

# PROGENY TEST 2009

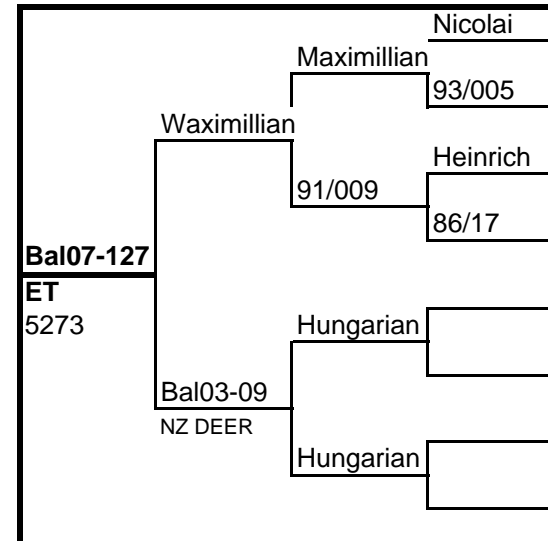

# PROGENY TEST 2009

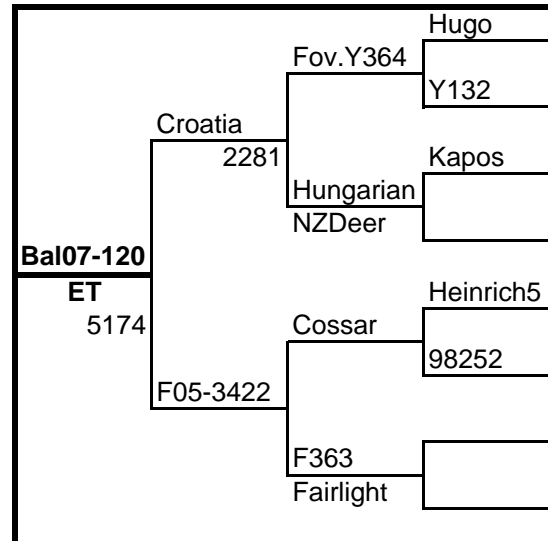
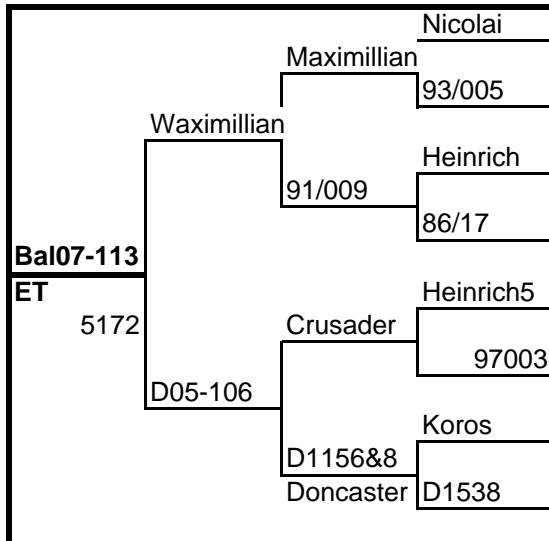
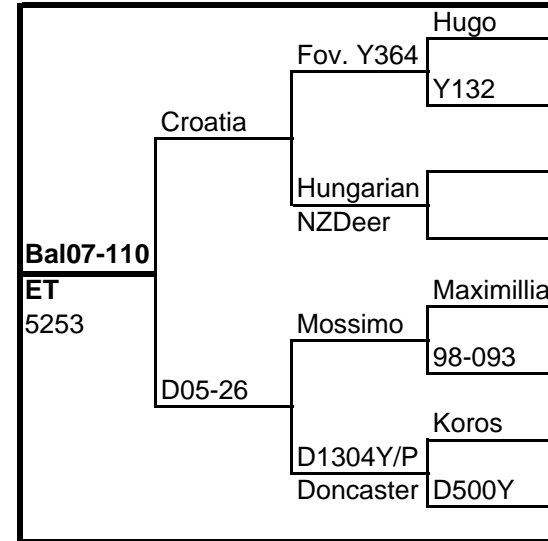
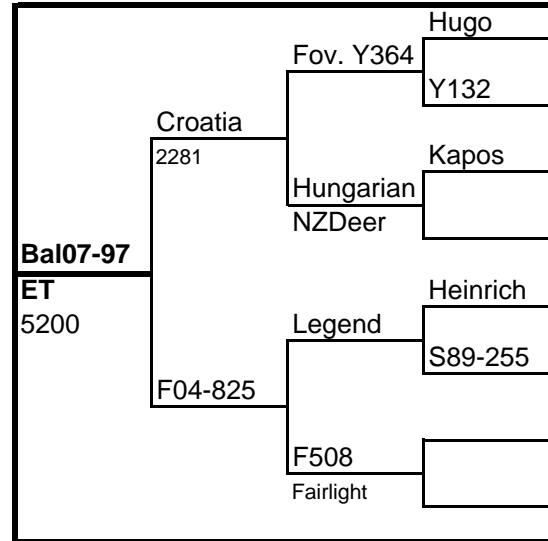
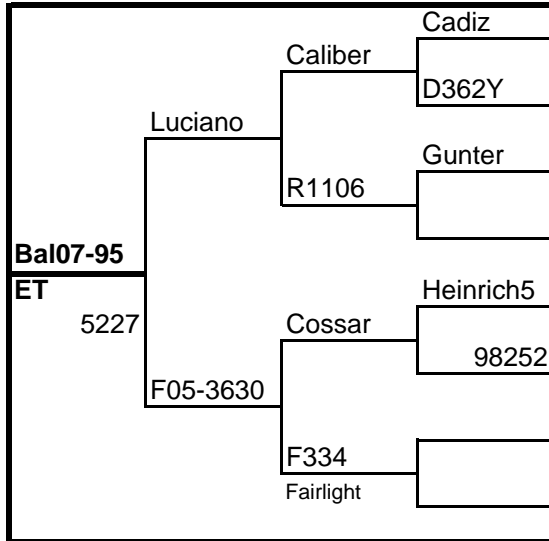
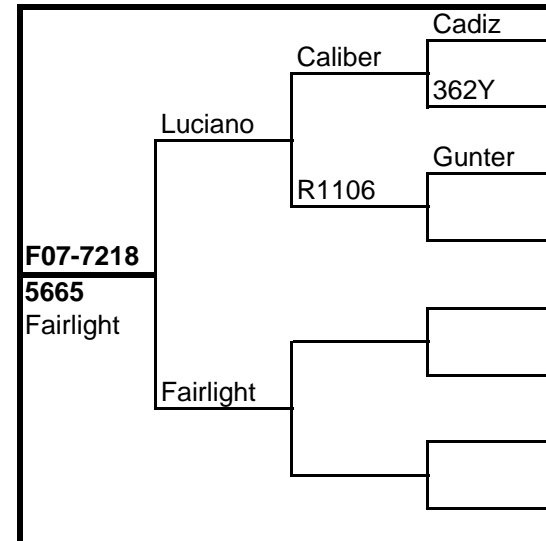
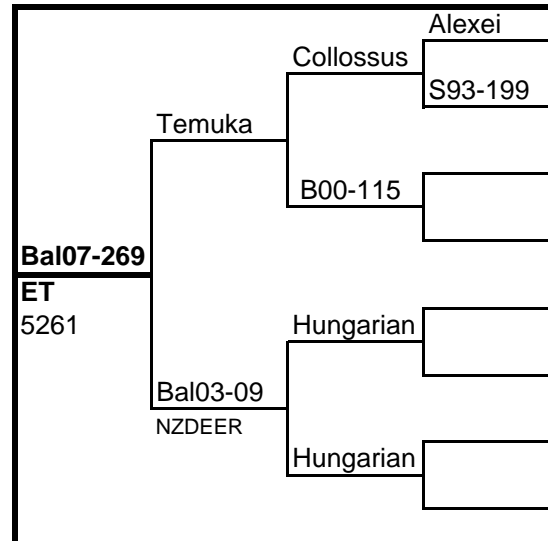
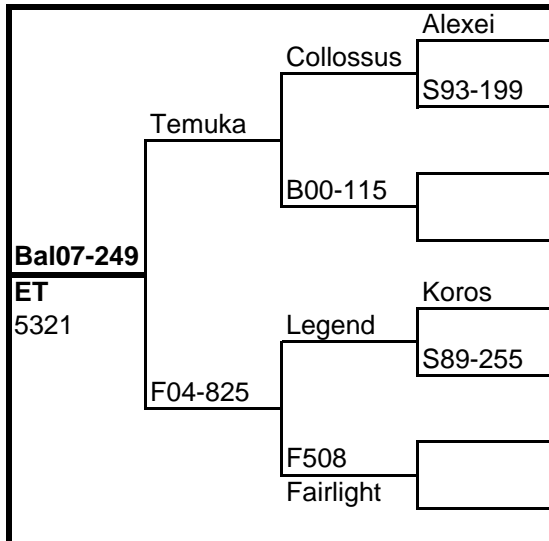
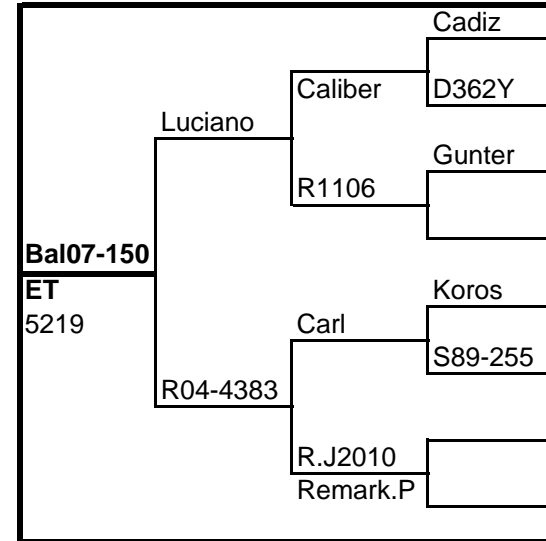
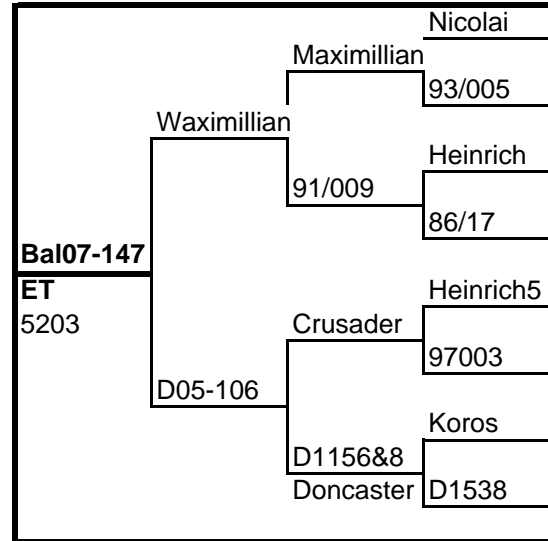
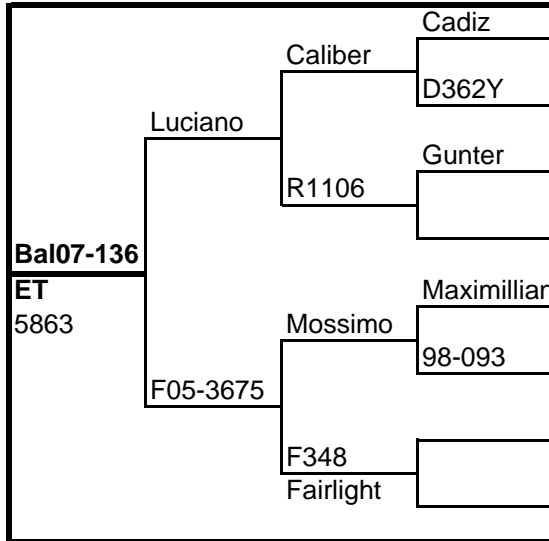

# PROGENY TEST 2009

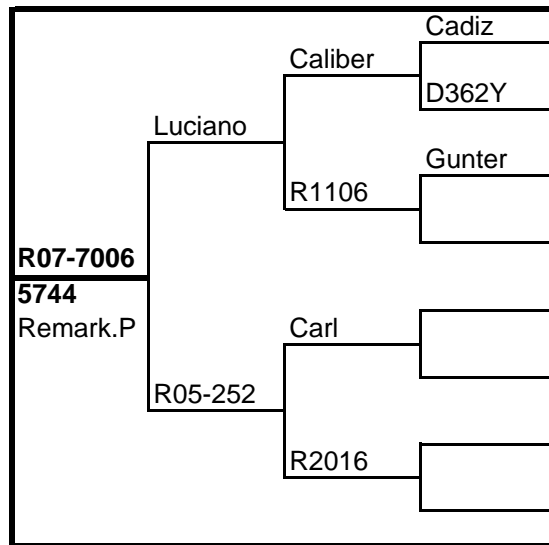
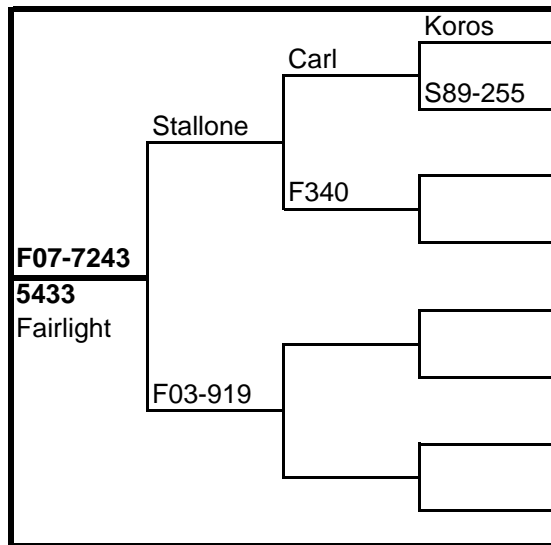

# PROGENY TEST 2008

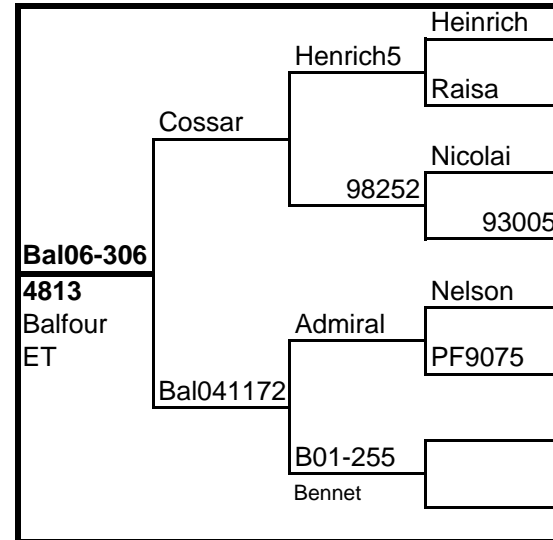
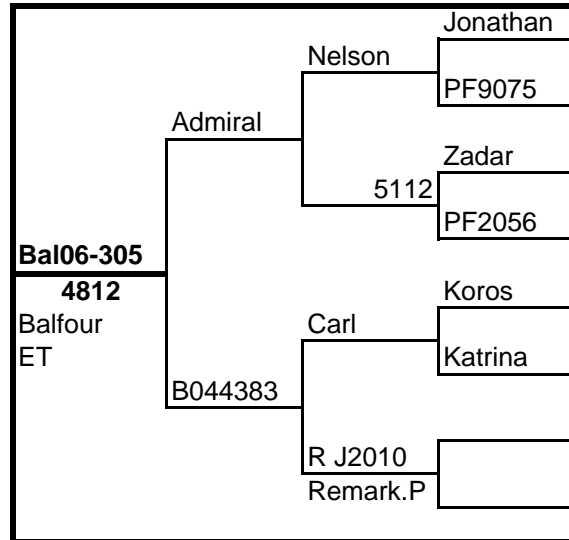
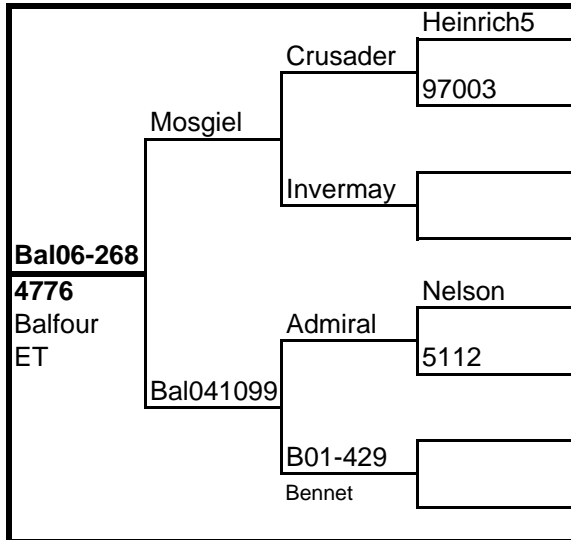
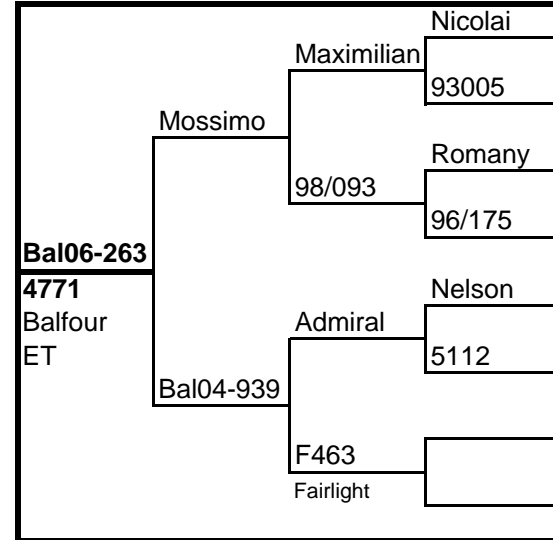
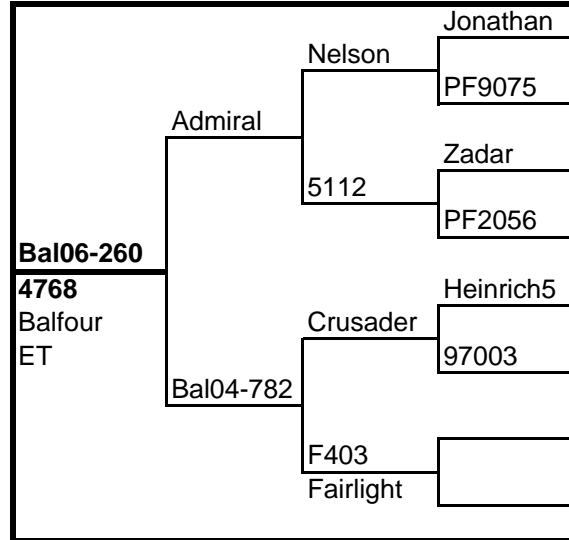
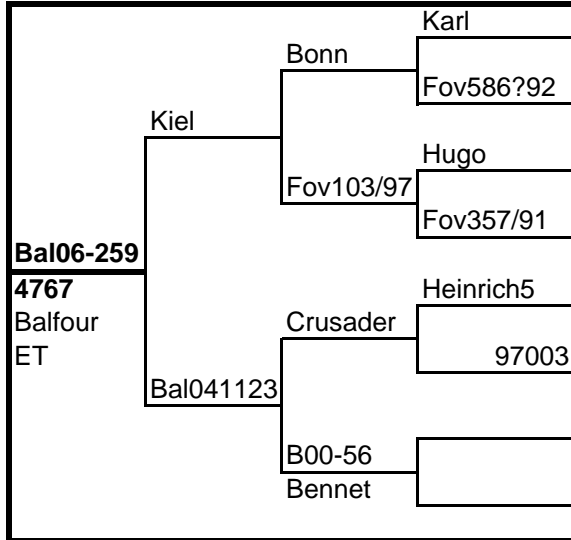

# PROGENY TEST 2008

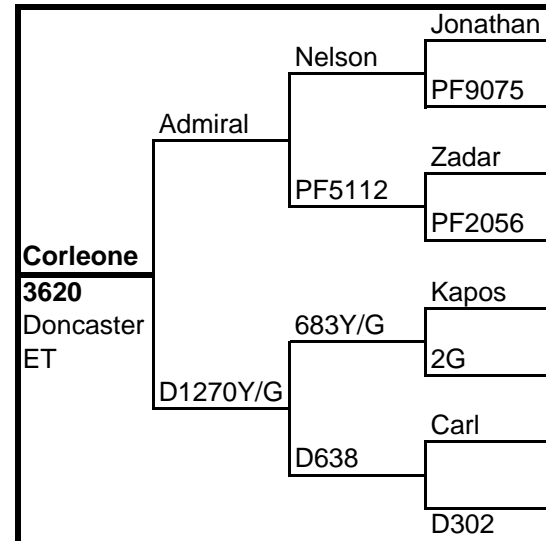
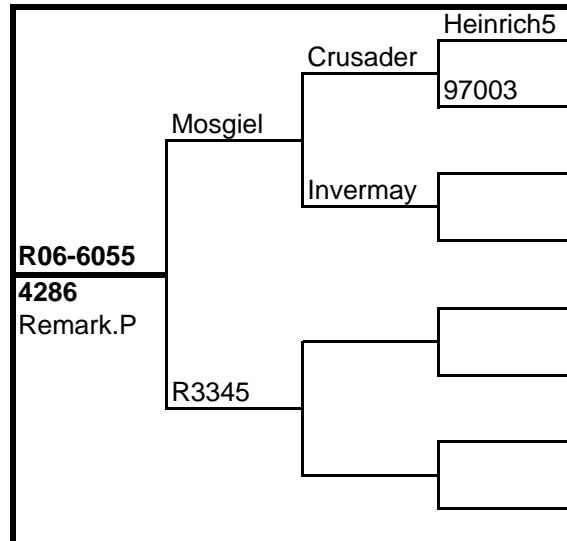
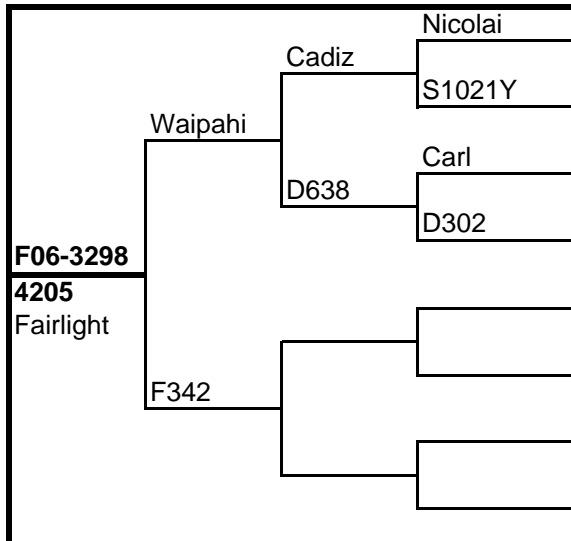
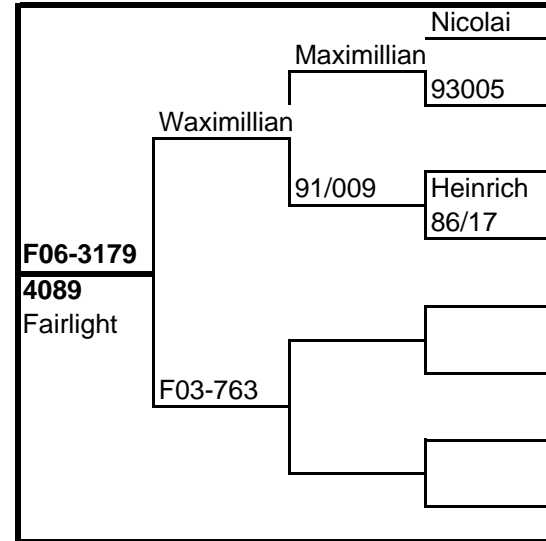
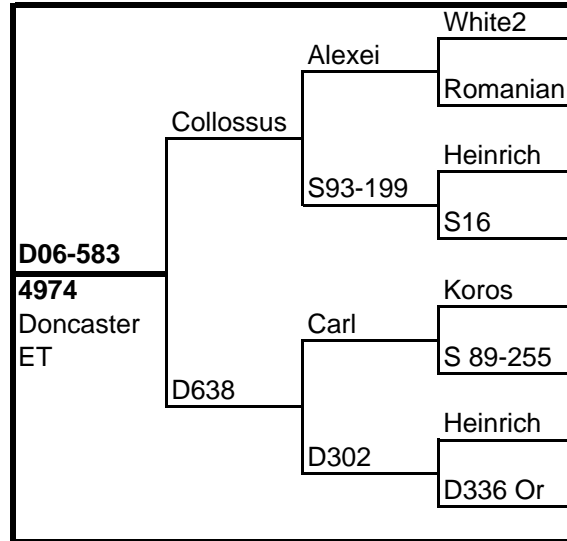
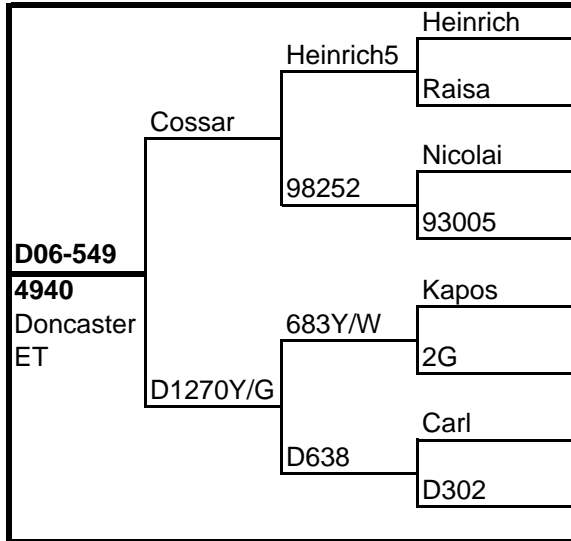

**PROGENY TEST 2007**

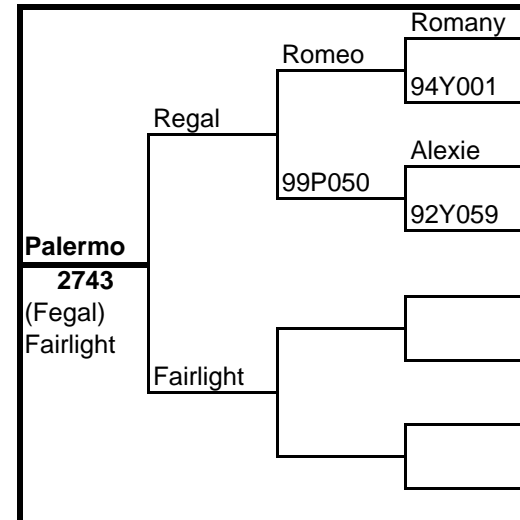
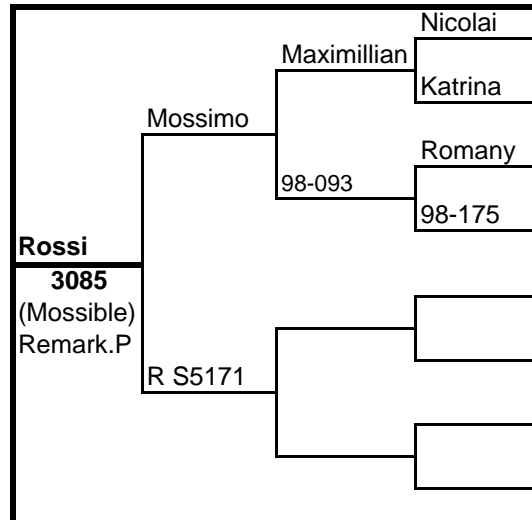
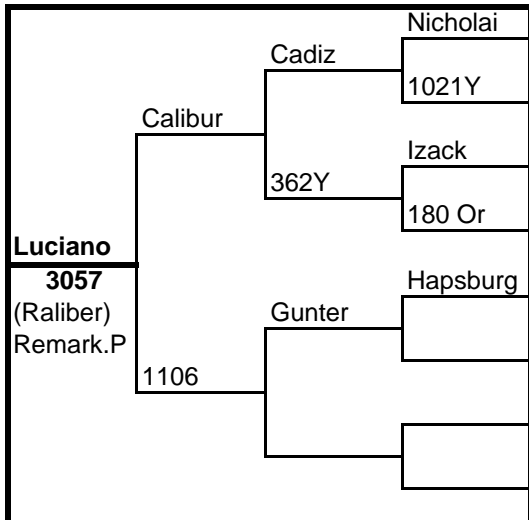
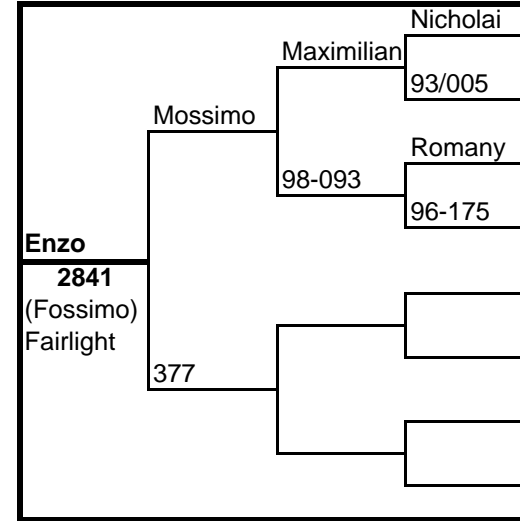
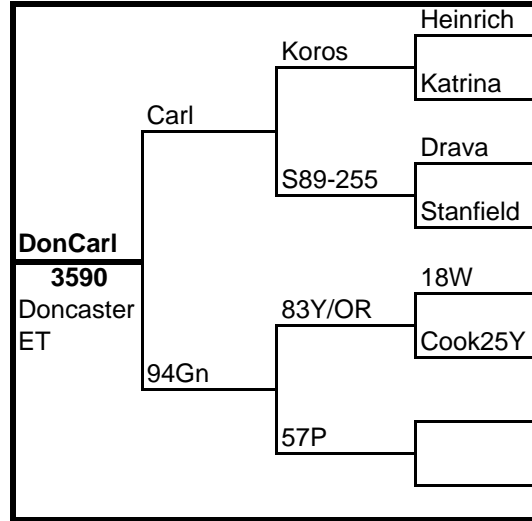
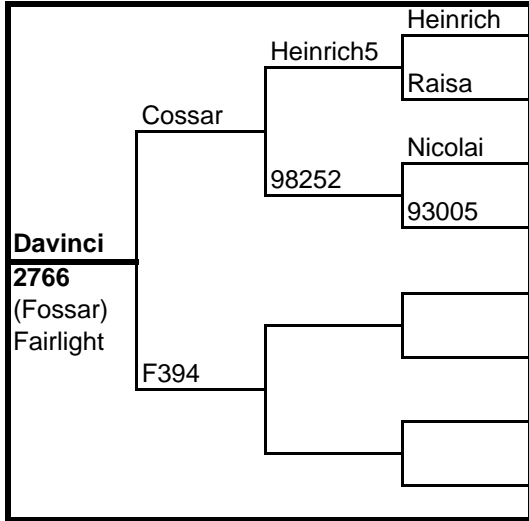

**PROGENY TEST 2007**

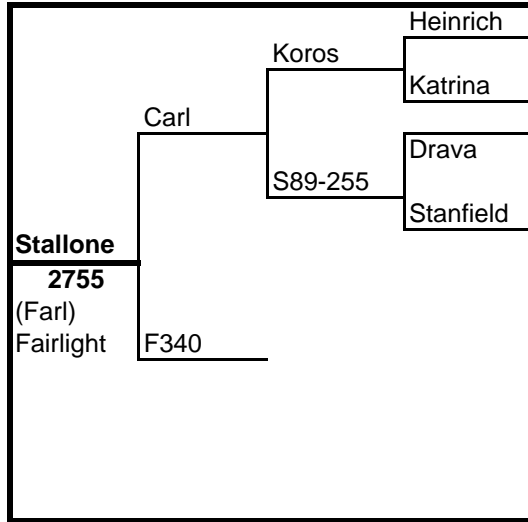

# PROGENY TEST 2006

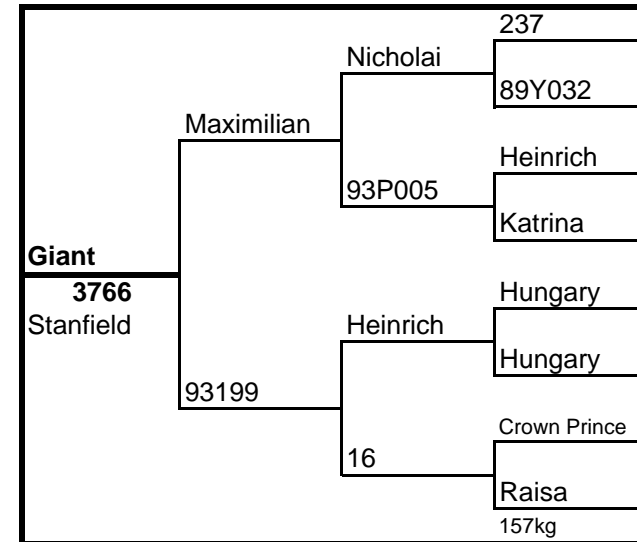
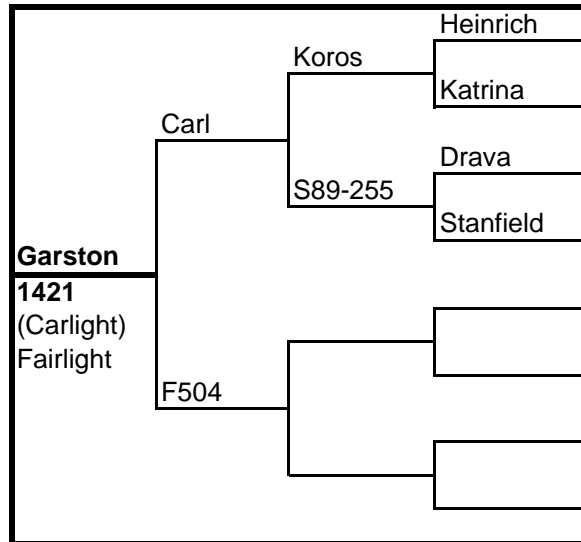
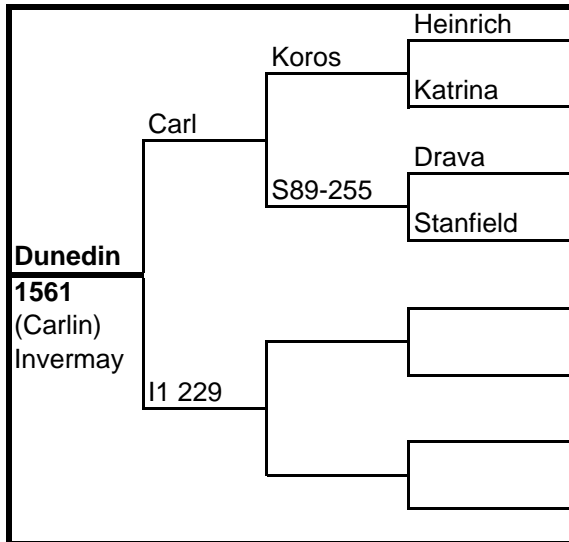
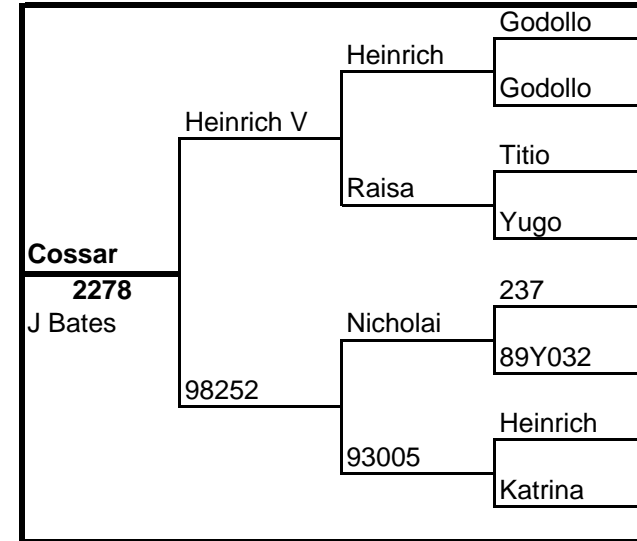
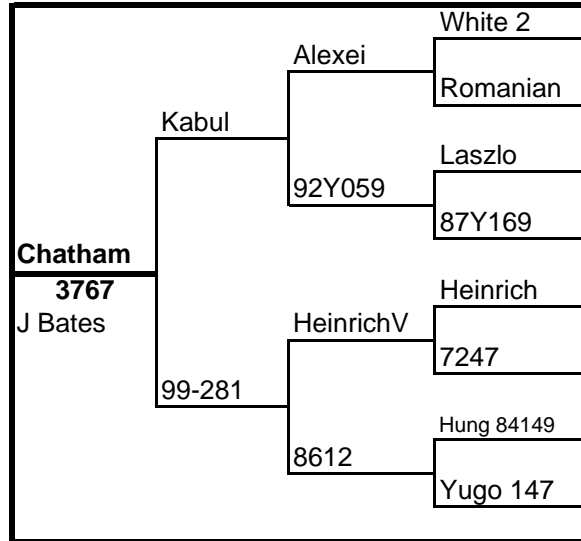
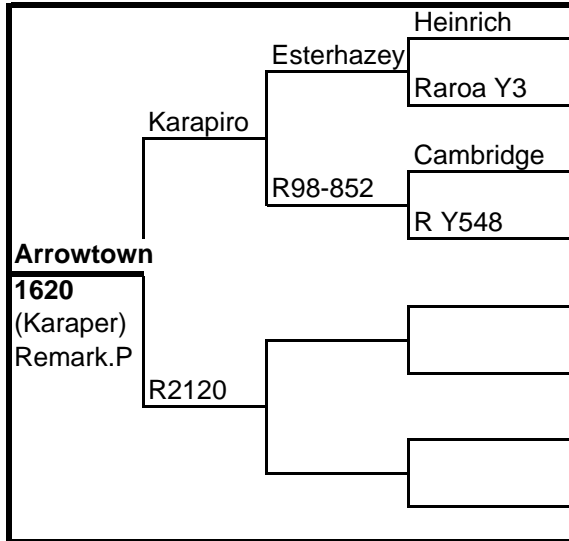

# PROGENY TEST 2006

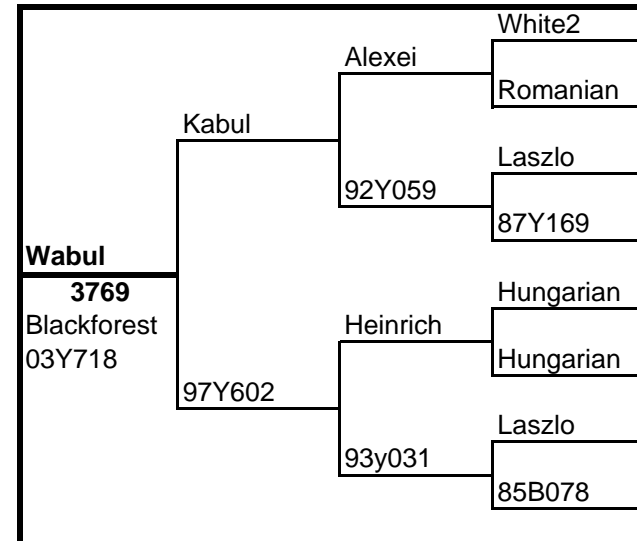
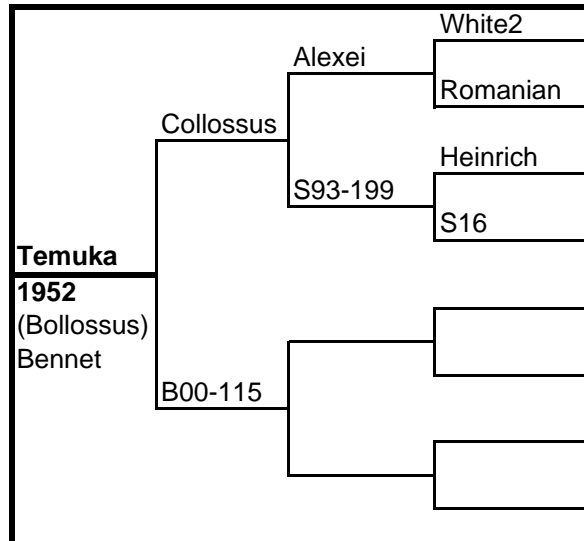
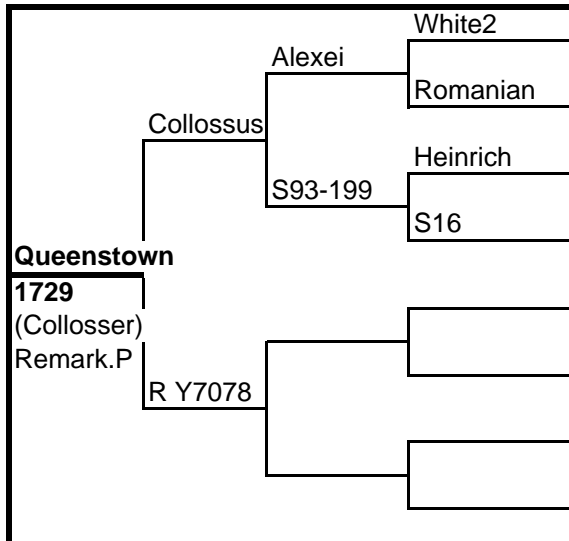
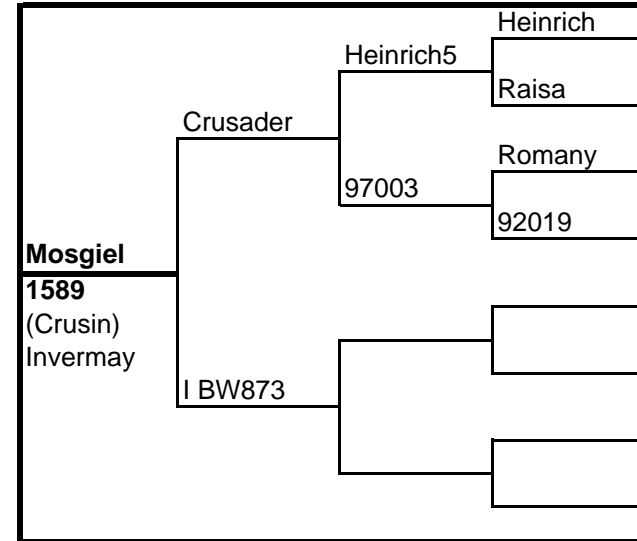
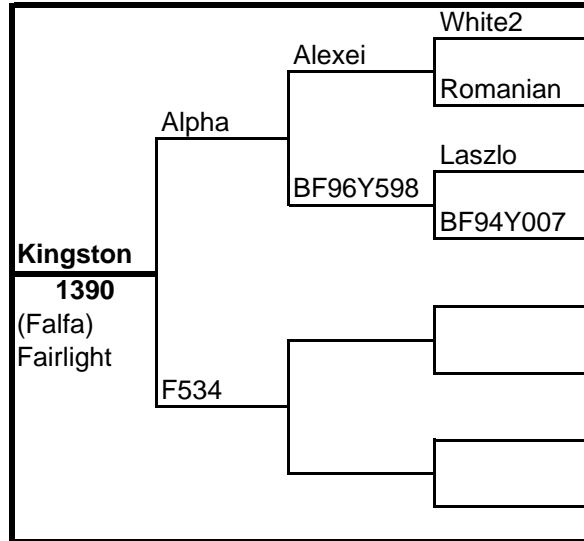
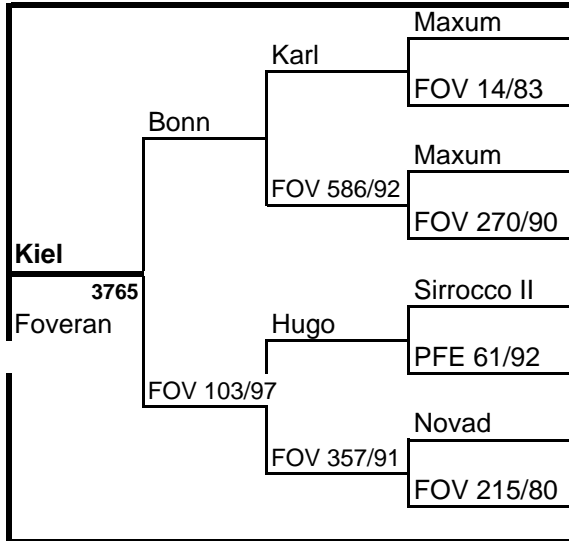

**PROGENY TEST 2006**

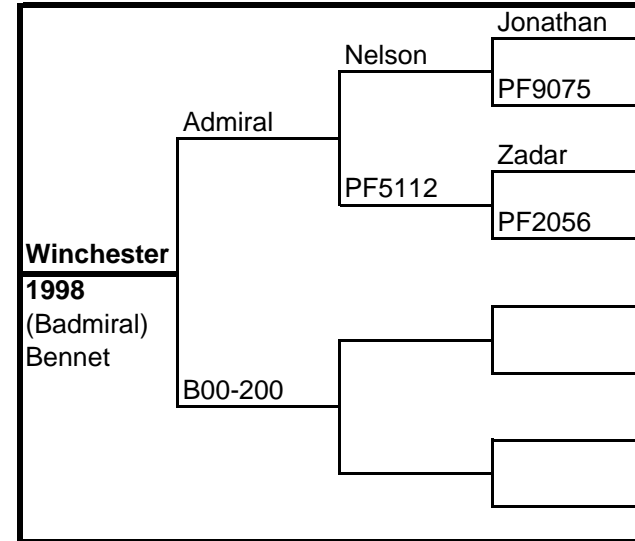
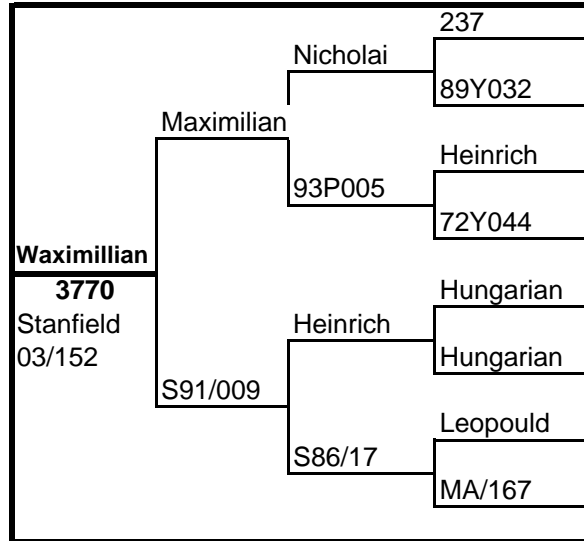
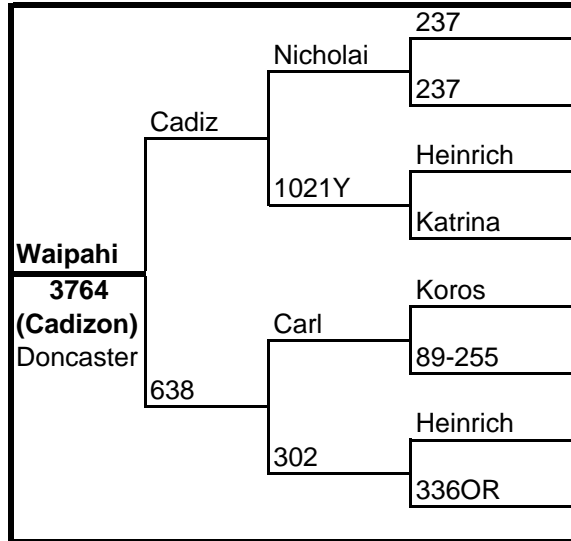

# PROGENY TEST 2005

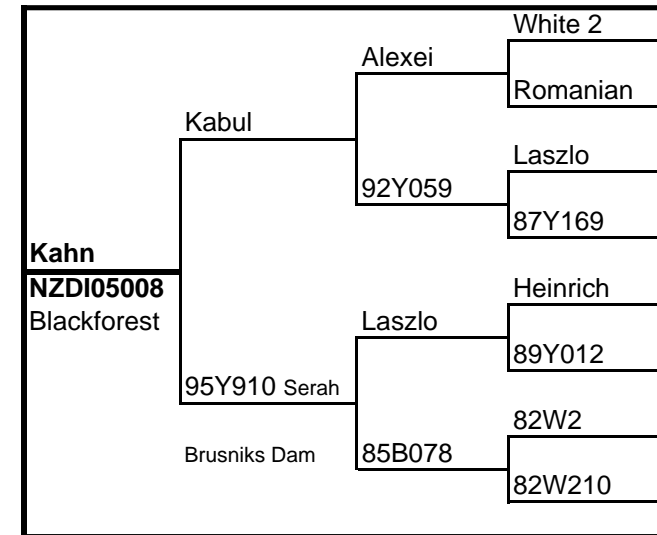
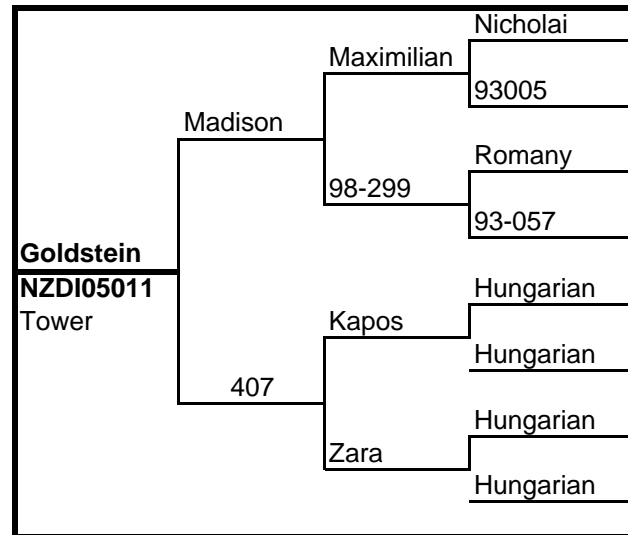
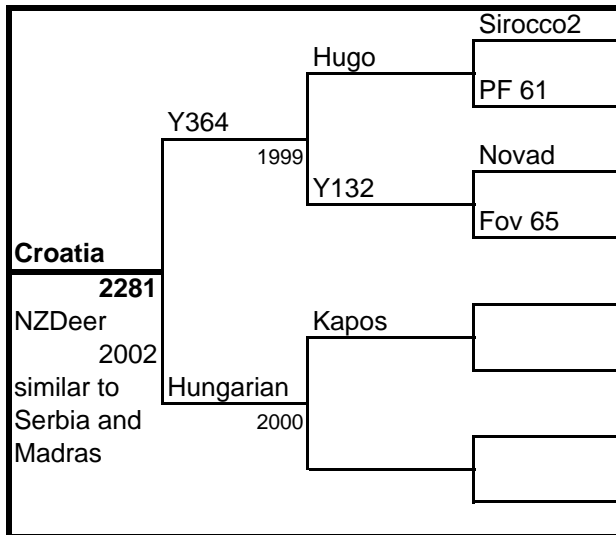
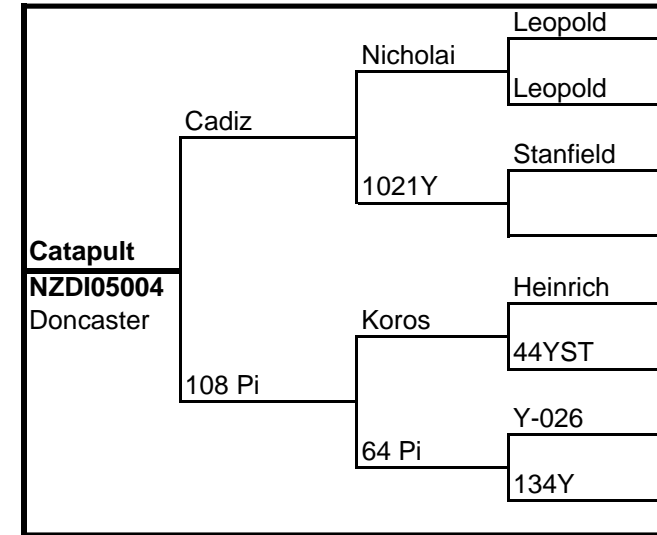
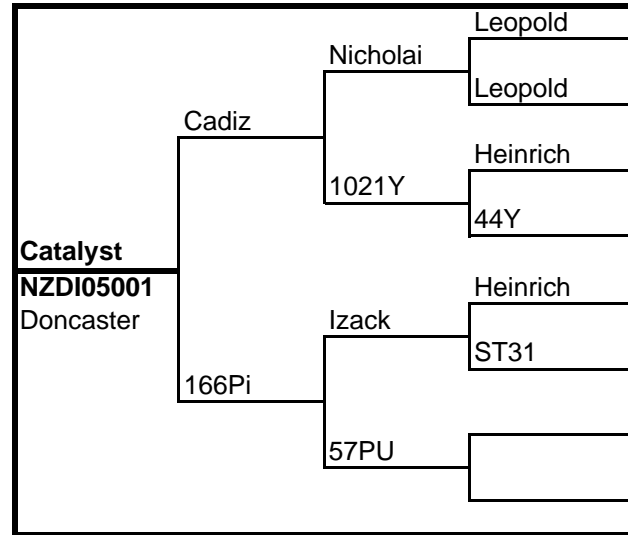
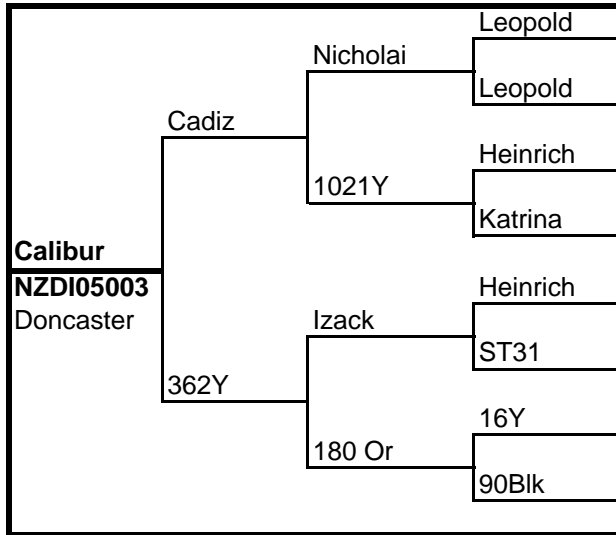

# PROGENY TEST 2005

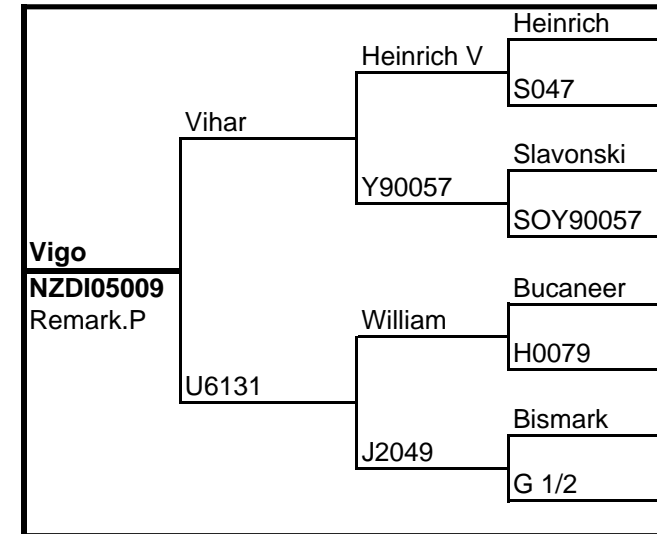
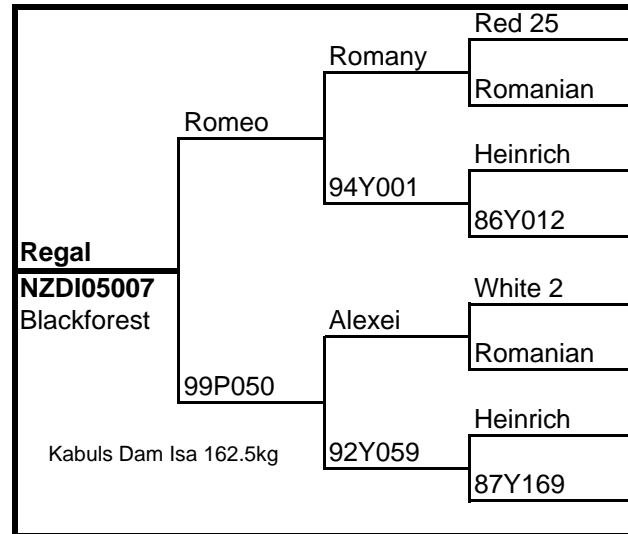
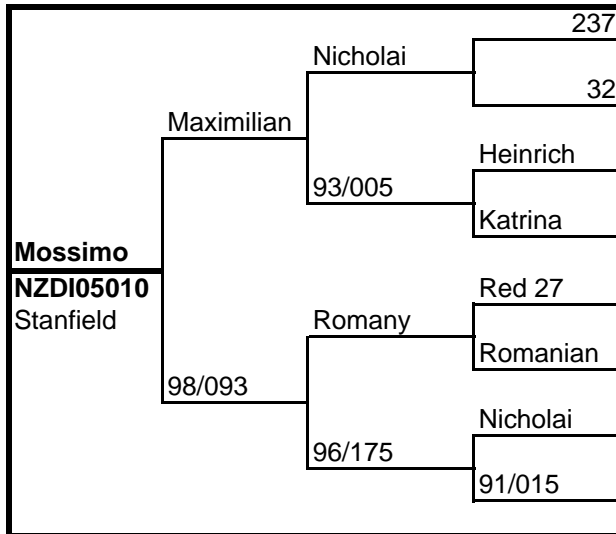
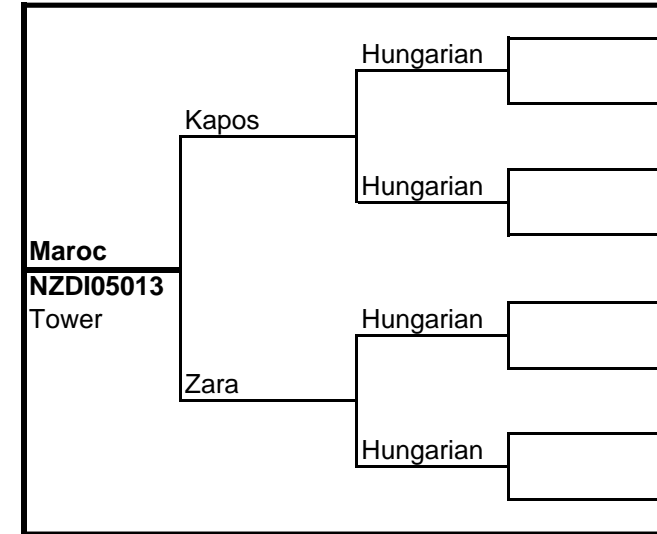
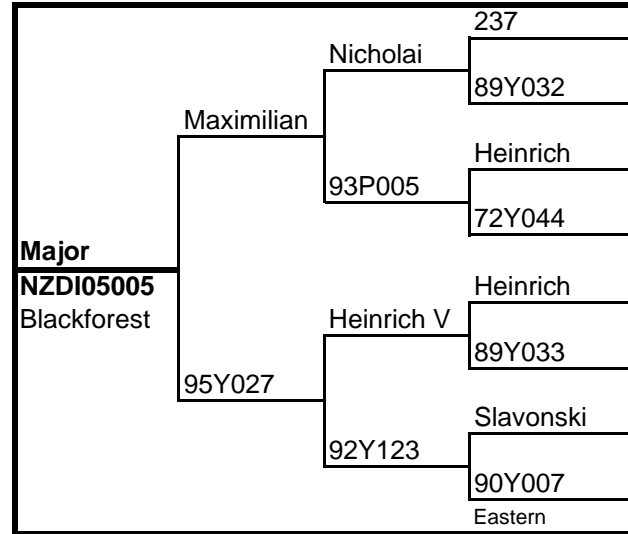
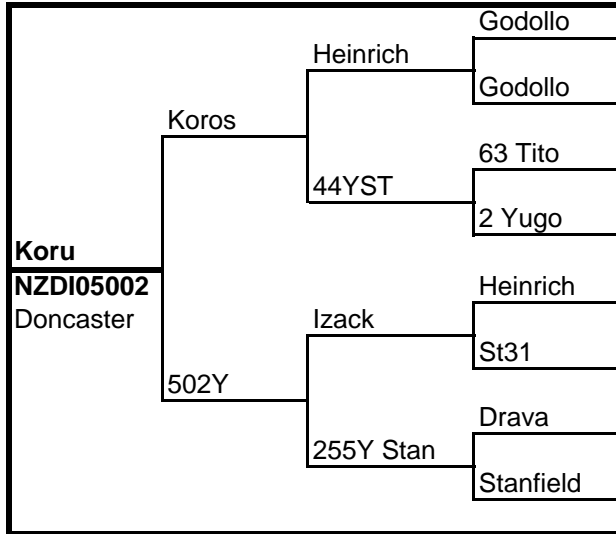

# PROGENY TEST 2004

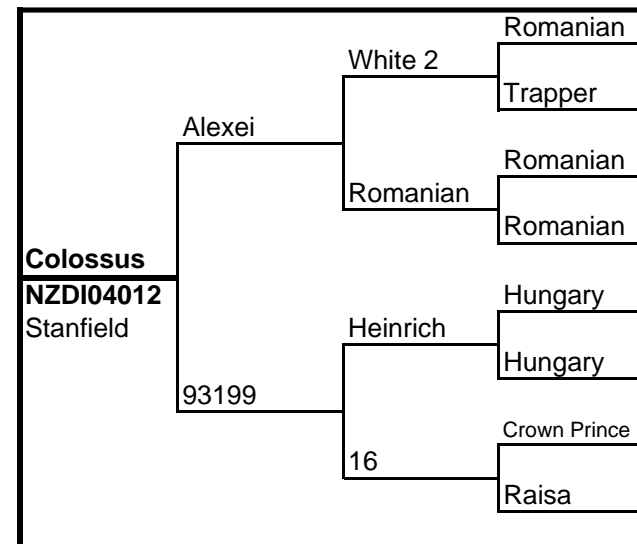
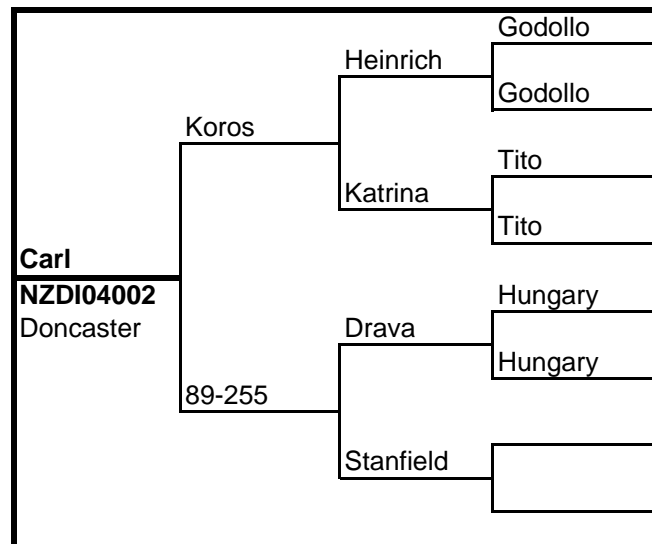
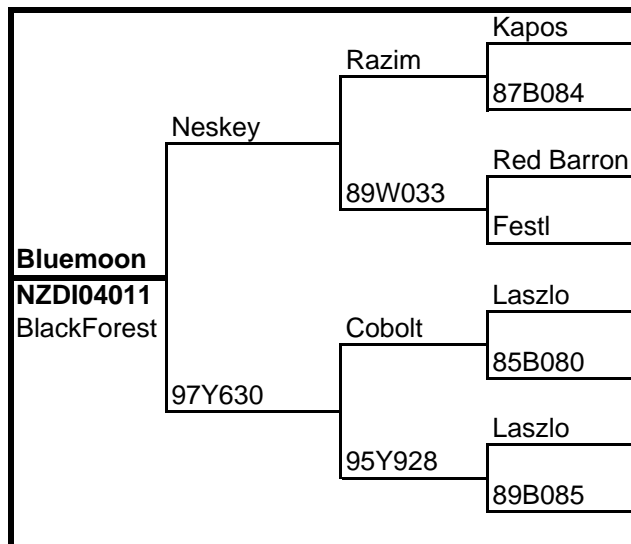
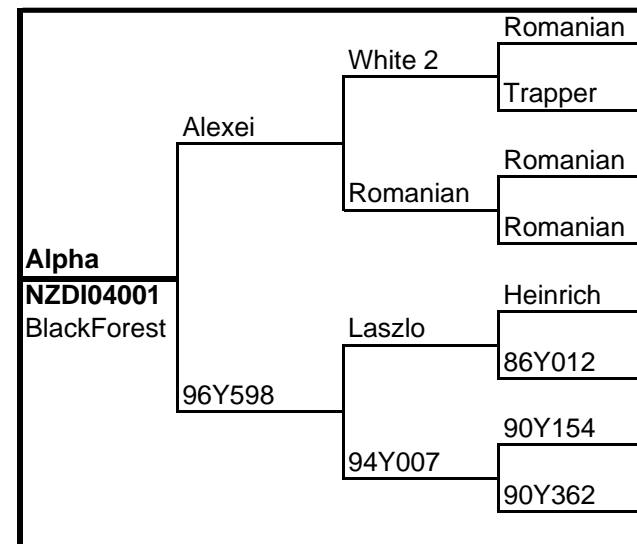
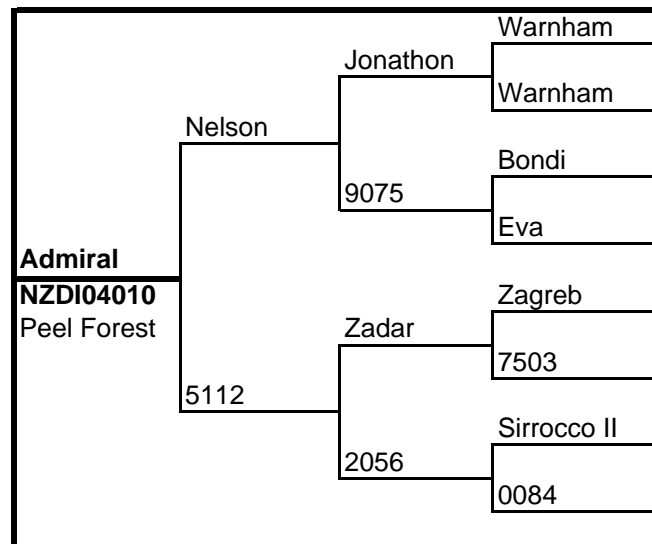
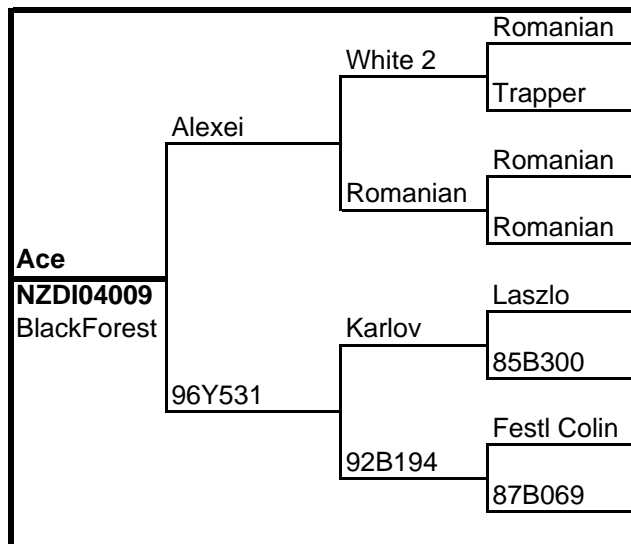

# PROGENY TEST 2004

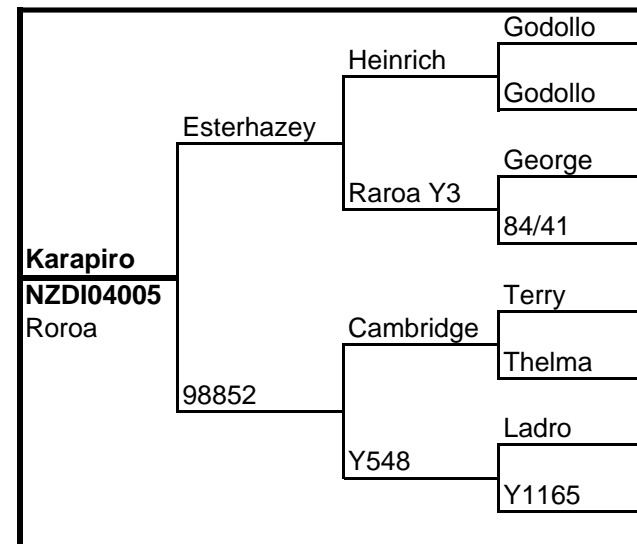
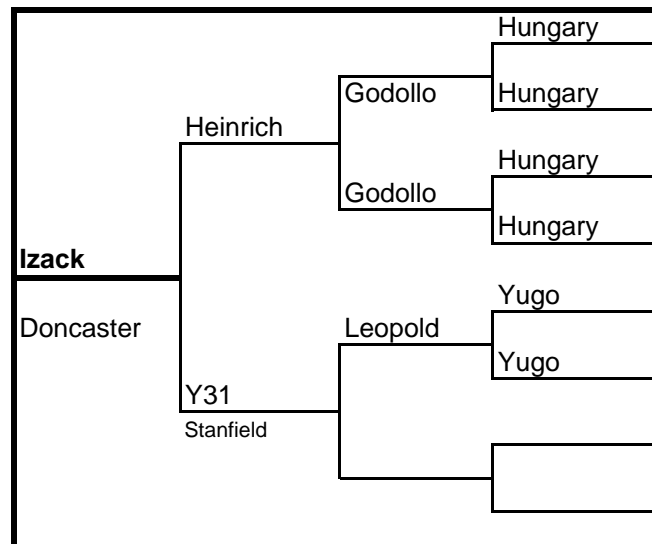
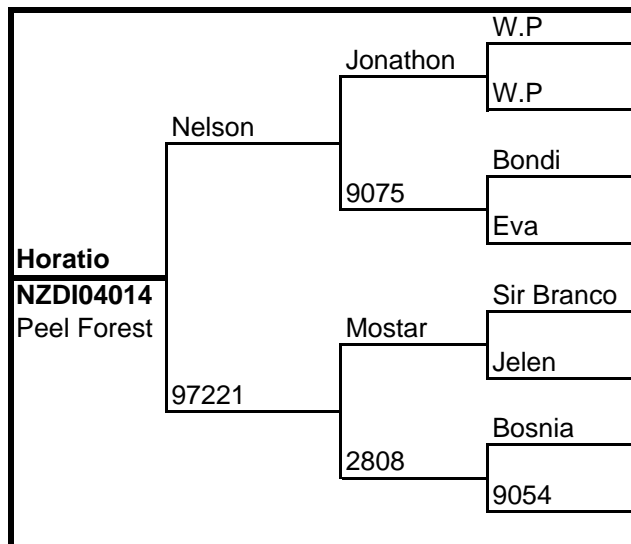
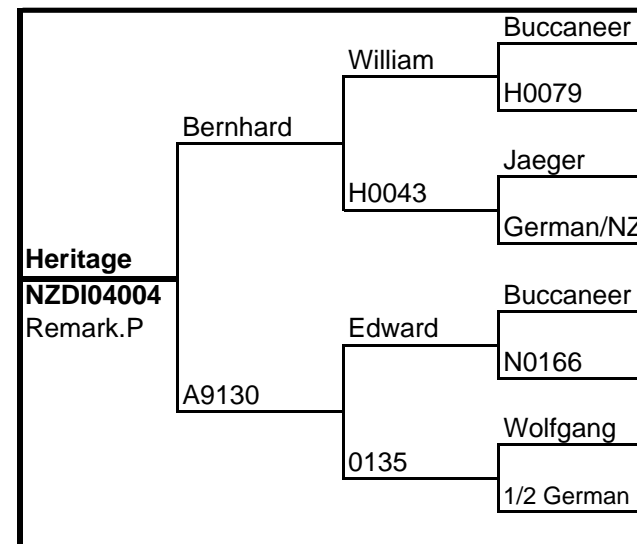
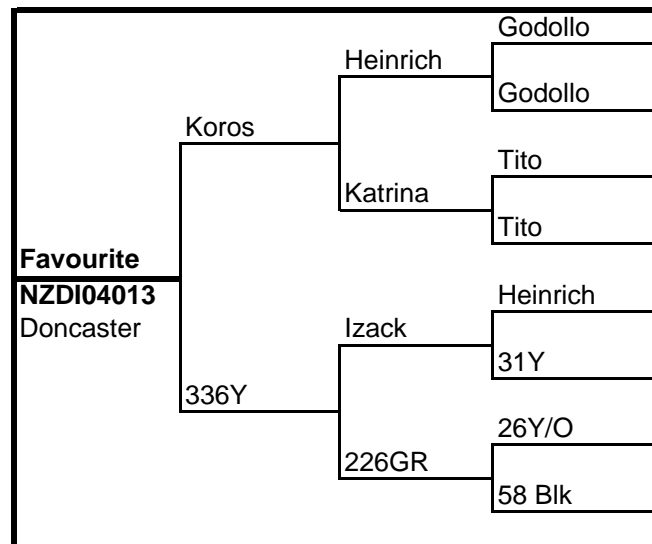
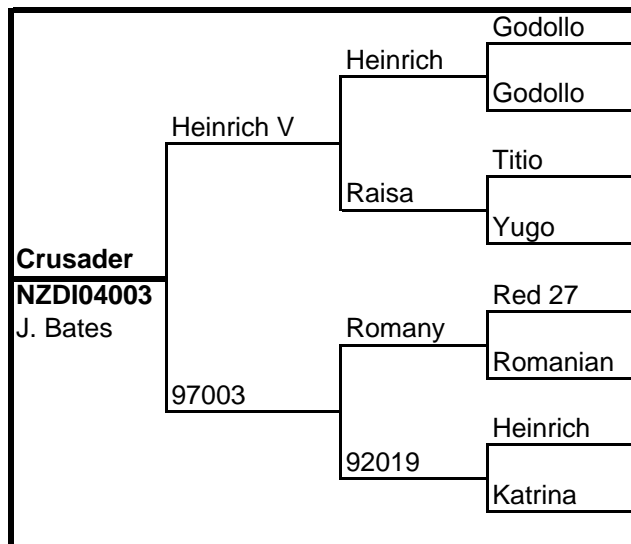

# PROGENY TEST 2004

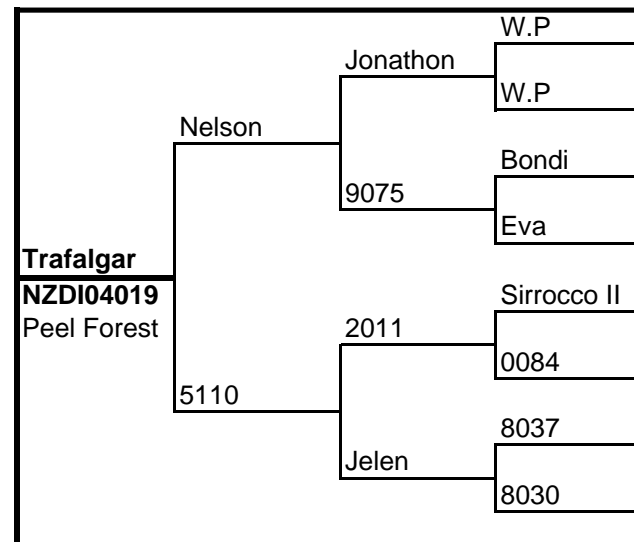
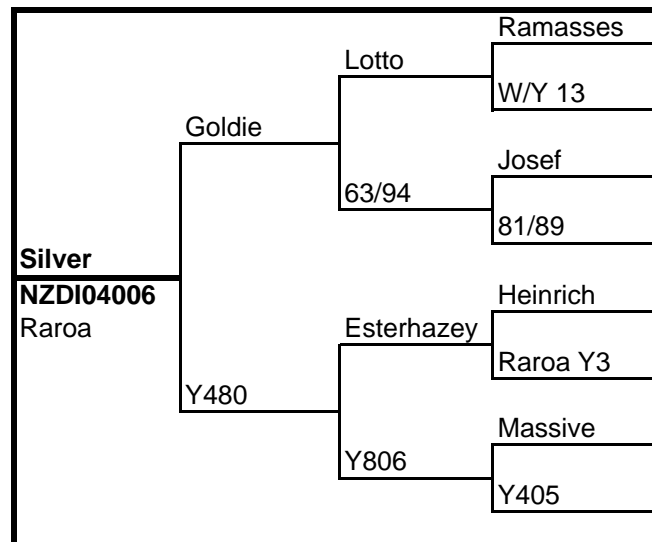
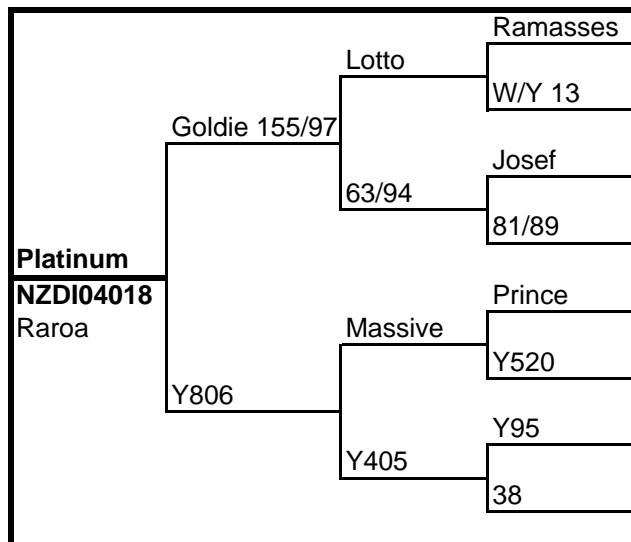
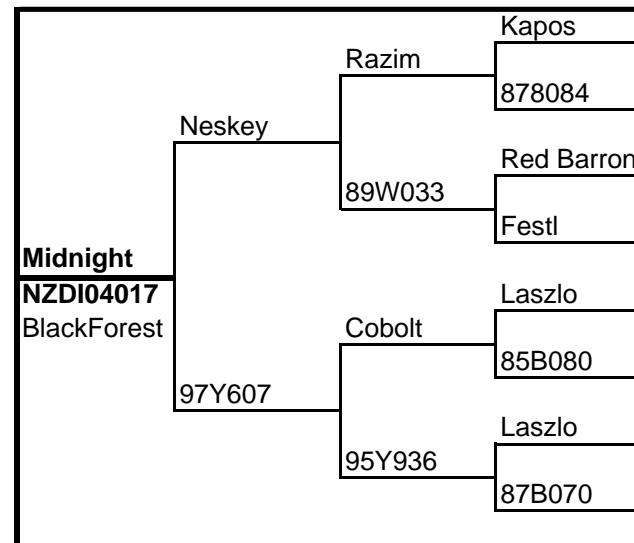
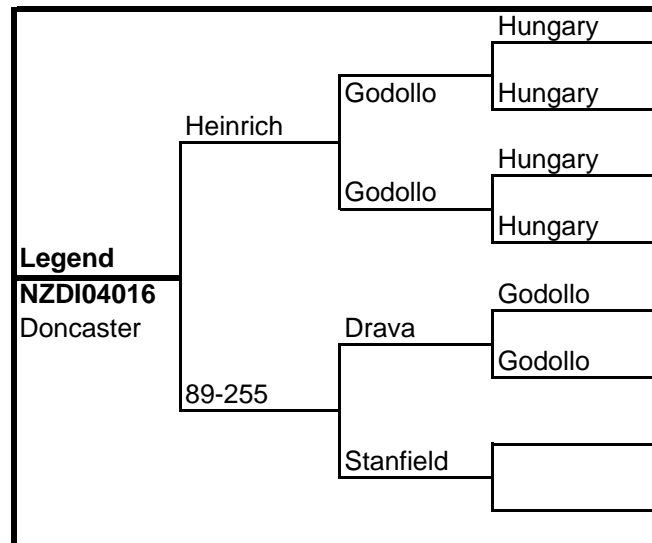
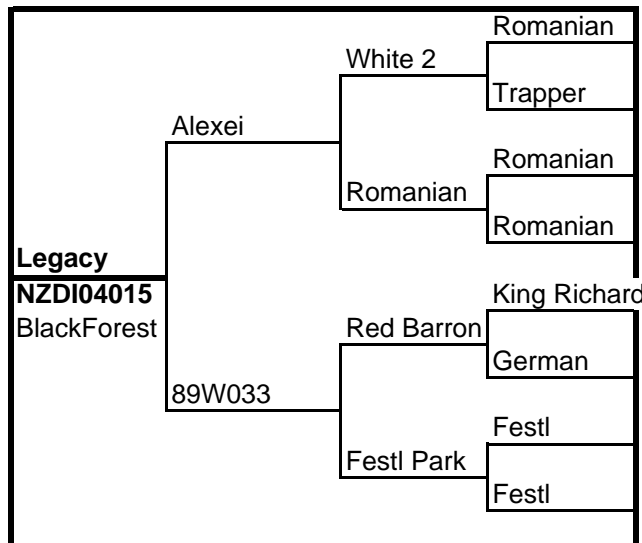

# PROGENY TEST 2004

